

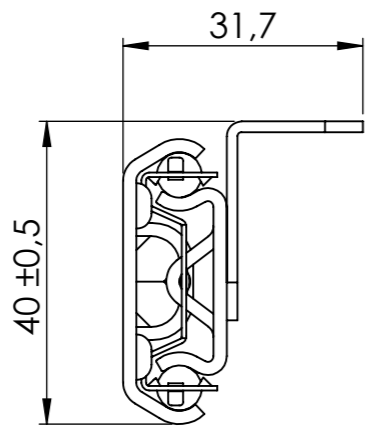

All property rights and rights to exploitation of copyright for this drawing data remain ours; they may not be made available to third parties without our consent.

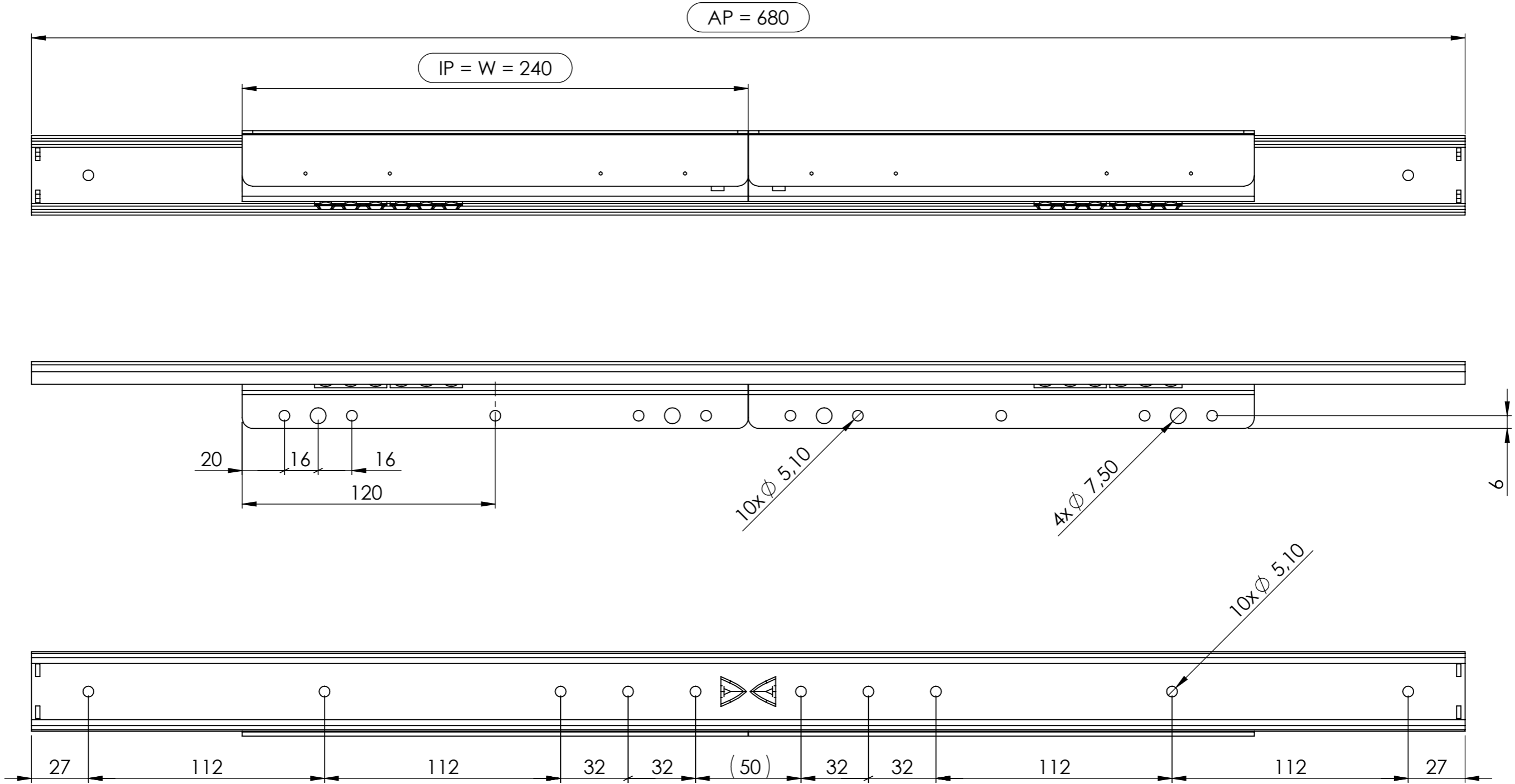

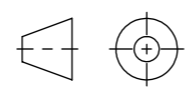

opening: ca. 521mm

Index	Change			Date	Name
 DIN ISO 128-30	Description: B-680.3-240.3-W240-KK2				
	Surface:		Material:		Weight: kg
 Transforming furniture	Name	Date	Company DEMOS		
	Signed Guzy	20.02.2017	Second Company:		
	Tested				
General tolerance: DIN ISO 2768 -1		Item No: 37068901		Scale 1:2	Page 1/3 A3

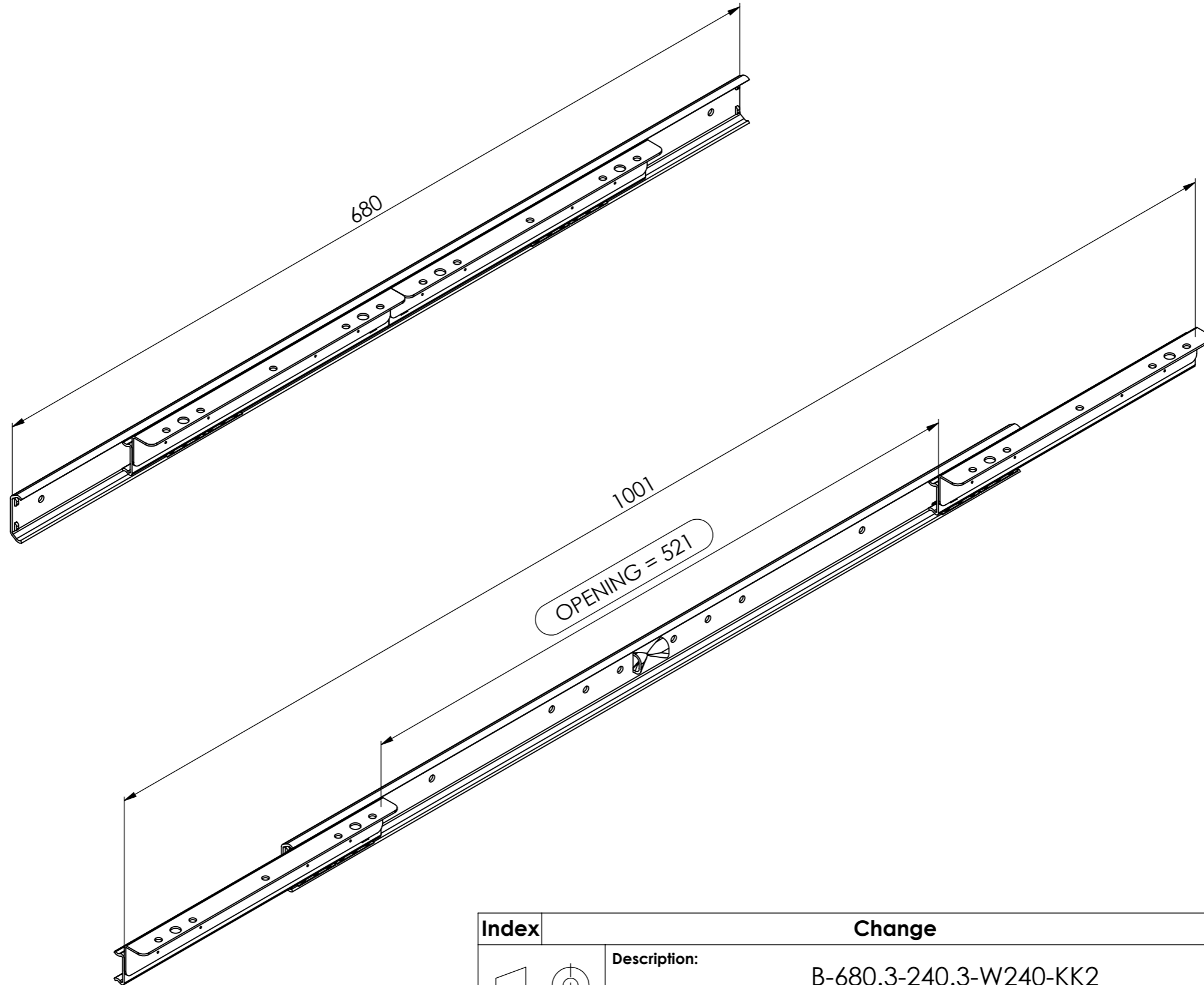
CLOSE

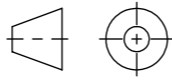

OPEN

Index	Change			Date	Name
 DIN ISO 128-30	Description: B-680.3-240.3-W240-KK2				
	Surface:		Material:		Weight: kg
 Transforming furniture	Name	Date	Company		
	Signed	Guzy	20.02.2017	DEMOS	
	Tested			Second Company:	
General tolerance: DIN ISO 2768 -1		Item No:		Scale 1:2	Page 2/3
					A3

All property rights and rights to exploitation of copyright for this drawing data remain ours; they may not be made available to third parties without our consent.